



INSTALLATION AND OPERATION MANUAL

**THE INSTALLER MUST BE DETA TRAINED AND REGISTERED
TO ENABLE THIS PRODUCT TO BE COMMISSIONED,
OTHERWISE THE WARRANTY IS INVALID**

THIS MANUAL MUST BE LEFT WITH THE PROPERTY

Item Code	Description
EVC7005	eVoomXT 7.4/22kW EV Charge Point

Contents

INSTALLATION MANUAL	3
1. Overview	4
2. Safety Instructions	5
3. Product Overview	6
4. Packaging Contents List	7
5. Installation Design	8
6. Installation	9
7. Commissioning the EV Charge Point	12
8. Trouble Shooting	15
9. Product Specification	16
OPERATOR MANUAL	
1. Overview	17
2. Safety Instructions	17
3. Charge Point Manager Setup	18
4. Using the charge point	19
5. LED Indicators	21
6. Trouble Shooting	22
7. Statement of Compliance	23
8. Warranty	23
9. Disclaimer	23

INSTALLATION MANUAL

Site: _____

Location: _____

Postcode: _____

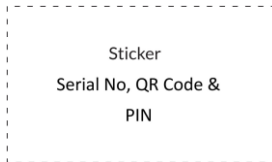

1. Overview

IMPORTANT

Please read this manual fully before starting the installation, maintaining or operating this unit

Description
<p>The deta.e AC charge point is designed to charge electric vehicles (hereinafter referred to as EVs).</p> <p>This product can be controlled via an APP and requires an internet connection for general use, software updates etc. This internet connection can be hardwired or via Wi-Fi. The eVoomXT also has 4G capability by adding a 4G data SIM card. For the purposes of commissioning, a mobile device which is Bluetooth enabled and has a mobile data connection, e.g. 4G, can be paired to the eVoomXT.</p> <p>Users with a mobile device with Bluetooth can control the eVoomXT, once paired, should the internet connection have failed.</p> <p>Intended Use</p> <p>The deta.e AC charge point is intended for charging of EVs only. It is suitable for both indoor and outdoor use.</p> <p>This product must be commissioned by an approved deta installer.</p> <p>The end user should register on the deta.e website by scanning the web QR code on the side of the charge point before being prompted to download the user APP.</p>
Product Features
<ul style="list-style-type: none">• Touch screen display displaying energy usage• Individual users can be billed for the electricity used• Single or three phase installations• Load balancing options available• APP control or via the RFID card• LED indications• Energy usage can be viewed within the APP• Scheduled charging can be set within the APP• Ethernet or Wi-Fi connection• 4G capability (SIM card not included)• Bluetooth connection for commissioning• Built in approved MID energy meter

2. Safety Instructions

Safety Instructions

The images and illustrations depicted in this manual may differ slightly from the actual product.

- Read and follow all warnings and instructions before installing and operating the charge point.
- Isolate the electrical supply before commencing the installation.
- Installation must be carried out by a qualified electrician ensuring the installation complies with the current edition of the IET wiring regulations - BS 7671.
- This equipment must be earthed through a permanent wiring system.
- Do not install or use this equipment near flammable, explosive, combustible materials, chemicals or vapors.
- Children should be supervised when around this equipment.
- Do not insert fingers or foreign objects into the electric vehicle connector.
- Do not use the equipment if any flexible power cord or EV cable is frayed, broken or otherwise damaged, or fails to operate.
- Use copper conductors only.
- Do not operate the equipment outside its operating temperature range of -30 to 50°C.
- Incorrect installation and testing of the equipment could potentially damage the vehicle's battery, components, and/or the equipment itself.
- Handle the equipment with care during transportation and installation. The mounting base must be installed on a flat surface and not twisted; do not use excessive force to pull when connecting the charge point to the base; do not step on the equipment, to prevent damage to it or any components.
- If using the Autel Charge APP to control your charge points at a single site, all charge points must be the same make.

WARNING Disconnect the charge point before installation resistance testing.

WARNING This device is intended only for charging vehicles.

CAUTION To avoid a risk of fire or electric shock, this product must be installed and connected to a permanent fixed installation. Ventilation not required during charging.

CAUTION The cable between the charge point and the EV should not be extended

CAUTION Risk of electric shock. Do not remove cover or attempt to open the enclosure. No user serviceable parts inside. Refer servicing to qualified service personnel.







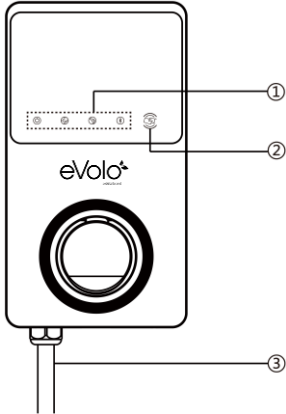
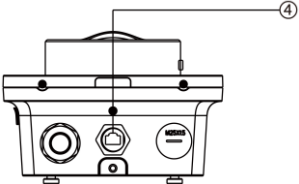
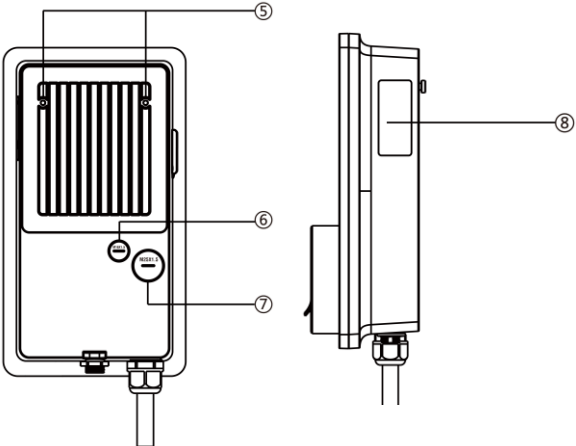
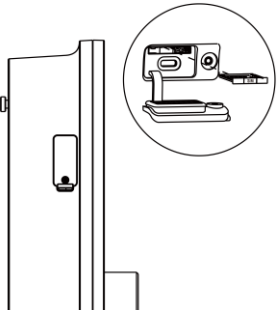

DANGER

If you use the equipment in any other way than described in this manual or other related documents, possible death, injury and damage to property can occur. For use with and for charging Electric Vehicles only. Use the equipment only as intended.

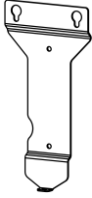
3. Product Overview

Features	
<p>Front View</p> 	<ol style="list-style-type: none"> 1. LED Indicators (from left to right): <ul style="list-style-type: none"> • Power LED • Internet Connection LED • Charging LED • Bluetooth Connection LED 2. RFID LED icon 3. Power Cable
<p>Bottom View</p> 	<ol style="list-style-type: none"> 4. RJ45 Ethernet Port
<p>Rear and Side View</p> 	<ol style="list-style-type: none"> 5. Mounting Lugs 6. Data Cable entry 7. Power Cable entry 8. Product Label – contains detailed website QR code and unique product QR code
<p>4G option (standard size)</p> 	

4. Packing List

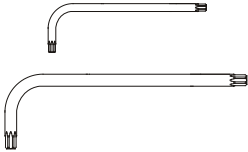
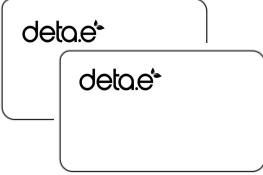
Parts Included			
Before you begin, ensure all the parts below can be found within the packaging box:			
Charge Point		Wall Mounting Bracket	
6 x 50mm Screws (x2)		Wall Plugs (x2)	
M5 x 10mm Screw (x1)		Waterproof Ethernet Cable Gland	
M16 Closed Grommet		M25 Closed Grommet	
Torx Security Key: T10 (x1) T25 (x1)		RFID cards (x2)	

5. Installation Design

Design Considerations

The eVoomXT is designed for use in communal areas where the user may be billed for the electricity being used to charge their EV.

No diversity to be allowed.

Dedicated Distribution Board

If multiple charge points are fed from a dedicated landlords 3-phase distribution board (with no other loads connected), the maximum current that an EV can draw automatically adjusts depending upon the number of EV's being charged.

To achieve this, the charge points must be 'grouped' together with one set to 'Primary' and a maximum of 8 'Secondaries' within the Config APP. The 'Primary' charge point must have a cabled internet connection and the other charge points need to be set to 'Secondary' and either have a cabled or Wi-Fi internet connection. The maximum current available on that phase for the charge points that are within that group needs to be set on the 'Primary' charge point within the Config APP.

If these charge points are connected on single phase radials, they should be distributed evenly across the phases and can deliver 7.4kW maximum. One charge point per phase needs to be set to 'Primary' and the others to 'Secondary'.

This principal applies for a 3-phase supply to each charge point, which can deliver a 22kW maximum, and all these charge points need to be grouped. Only one charge point is set to 'Primary' with a maximum of 8 'Secondary' chargers.

Distribution Board feeding EV's and other loads

If charge points are connected to a distribution board that also feeds other loads, MID energy meters are needed to monitor the current that the distribution board is drawing.

The charge points need to be 'grouped', configured into 'Primary' and 'Secondary' and have internet connections as above. A RS485 data cable connects the MID energy meter and the 'Primary' charge point.

The maximum current available to the distribution board needs to be set on the 'Primary' charge point within the Config APP. The 'Primary' charge point will monitor current being drawn against maximum current available, and manage the remaining available current between EV's connected to these charge points.

Loss of internet

If the internet connection fails, the charge points will deliver a maximum of 6A.

6. Installation

Location of EV Charge Point

- Install your charge point on a flat and vertical surface capable of supporting its weight (the charge point has a weight of approximately 4.2kg)
- Position the charge point in a location where it is not vulnerable to being damaged
- The eVoomXT charge point is supplied with a combined power and RS485 cable; termination in a suitable enclosure should be considered
- Data cabling should also be considered and requires a RJ45 plug to connect to the charge point
- The car charge point can be mounted on a suitable post
- If using Wi-Fi for communication, signal strength needs to be determined before installation commences
- For a more reliable internet connection, it is recommended that an Ethernet cable is routed to the charge point
- Consider the charge point location relative to the vehicle, i.e. whether the EV's charging cable will sufficiently reach the vehicle's charging port

Cable Entry

- The eVoomXT is fitted with a supply cable for terminating in a separate junction box
- This cable has combined RS485 conductors
- The rear cable entry for data cables (A) is recommended. Alternatively, the charge point has an external RJ45 connection (B) at the bottom

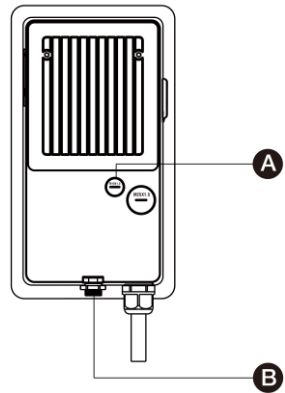

Installation

1. Fix the mounting bracket in the required position, noting the correct orientation
- It is recommended that the socket height is 700 – 1000mm (as recommended in PAS1899)
 - Use the 6mm screws and wall plugs supplied to fix to a solid surface
Wall plugs require a 8mm \varnothing hole x 50mm

If fitting a data cable from the rear, move to Step 2, if not move to step 6.

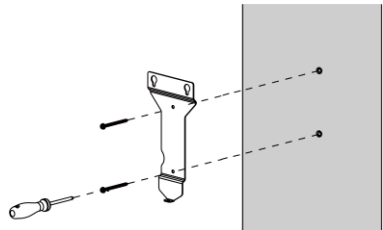

2. Remove the facial cover
 - Remove the two screws (A) at the bottom of the cover with the screwdriver type T10
 - Unclip the cover (B) from the bottom

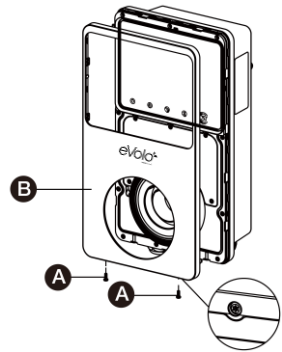

3. Remove the terminal cover
 - Unscrew the five screws (C) to remove the inner terminal cover (D).

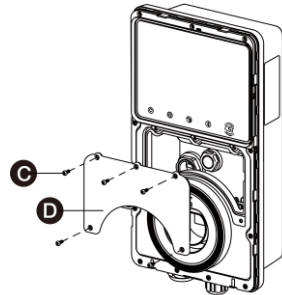

4. Connect/Terminate Data Cables
 - Remove the blanking plugs from the rear cable entry points and replace glands or grommets as required
 - For Cat5e/6 cable - remove existing connector (which links to the port at the bottom of the charge point) and connect new connector
 - For RS485 – again, remove and isolate existing conductors, terminate new conductors

5. Reinstall the terminal cover and facial cover
6. Hook the charge point onto the mounting bracket and tighten the bottom M5 x 10mm securing screw

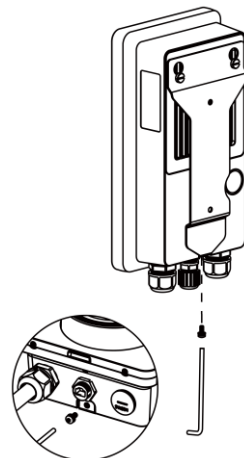
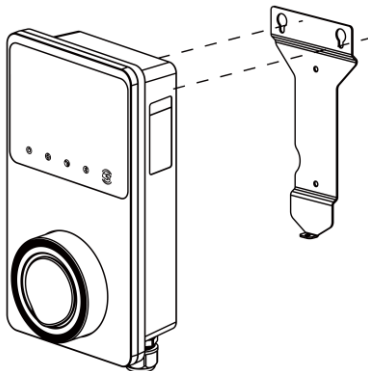

7. Terminate Mains Cable

- Connect the below wires:
 - Earth (PE): green/yellow striped
 - Neutral (N): blue
 - Live (L1): brown
 - Live (L2): black (3-phase)
 - Live (L3): grey (3-phase)
- The cable has RS485 conductors combined – terminate these if required, otherwise terminate in separate terminal block or wrap with insulation tape

Internet Connection

Ethernet Cable

The ethernet cable can be plugged into the port at the bottom of the product.

Alternatively, the rear cable position can be used. In this case, remove the cable plugged into the port under cover (Q)

- Insert the Ethernet cable through the M16 grommet from the back entry
- Connect the Ethernet cable to the port

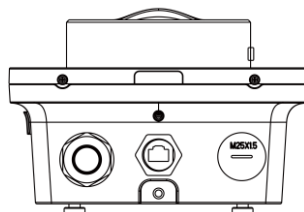

4G Connection

If a cabled connection is not possible, a 4G connection can be obtained by inserting a 4G SIM card into the slot on the left hand side of the charge point.

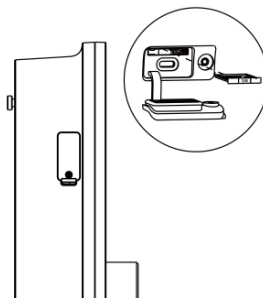

RS485 Communication

RS485 communication cable, e.g. from an energy meter, CT clamp, is terminated on the rear of the EV charge point, below the RJ45 data connector.

Electrical Installation Testing

The charge point should be disconnected from the installation during insulation resistance testing.

7. Commissioning the EV Charge Point

Commissioning

The deta.e EV Charge Point must be set up and commissioned by an approved installer.

The charge point should be disconnected from the installation during insulation resistance testing.

- When power is initially applied to the charge point:
 - The loading screen will appear:



- The power LED should illuminate green and will go through a series of self-checks
- If the Charging LED illuminates yellow or red, see LED Indicators In Operator User Manual section below. If the problem persists, contact Technical Support
- Following boot up, the touchscreen displays the home/standby screen

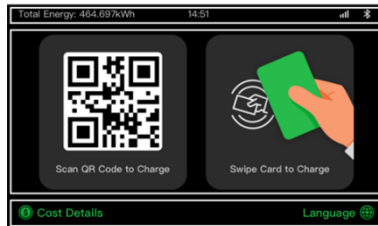

The QR code on the home/standby screen is the product ID

The EV Charge Point requires the Autel Config commissioning APP to be downloaded from www.deta-e.co.uk. The APP is password protected.

If an internet connection is not available from the property or a 4G connection via a data SIM card not be available, the charge point can be commissioned using a mobile device which is Bluetooth enabled and a mobile data connection.

1. Ensure Bluetooth on the mobile device is enabled
2. Add and scan the Product ID QR code which is on the rating label on the side of the product
3. If prompted, enter the unique PIN number
 - The PIN can be found on page 3 of this Installation and Operation Manual
 - The Product serial number number appears at the top your screen
4. Set the following by selecting each parameter:

Parameter	Action
Wi-Fi Connection	<ul style="list-style-type: none"> • If no internet connection, ignore this parameter • If internet connection is hardwired, ignore this parameter • If internet connection is wireless, select 'Add Network' and follow the on screen prompt to add a wireless network • Press Back(<) to return to the parameters menu
Charger location	<ul style="list-style-type: none"> • Verify the charger location on the map within the APP (assuming location services switched on), and set as required • Select 'OK' to save setting and return to the parameters menu
Charge Current Limit	<ul style="list-style-type: none"> • Select maximum charging current as determined by the installation/circuit design • Select 'OK' to save settings and return to the parameters menu
Randomised Delay	<ul style="list-style-type: none"> • This must be set to On • Press Back(<) to return to the parameters menu
Schedule	<ul style="list-style-type: none"> • This must be set to On
Firmware Update	<ul style="list-style-type: none"> • Check firmware is up to date
OCPP (Open Charge Point Protocol)	<ul style="list-style-type: none"> • This defaults to the Autel® cloud • Alternative cloud management systems can be chosen from dropdown menu • Do not change without consulting deta Technical Support
APN	<ul style="list-style-type: none"> • This changes the mobile Access Point Network that the charge point is connected to. If the charge point is connected to the internet via a 4G data SIM card, APN settings may need to be manually configured. • To adjust the APN settings, select the APN menu, input the APN name as required by the SIM manufacturer and choose the internet protocol and authentication type

Local DLB	<ul style="list-style-type: none"> • Select: Set as 'Primary Charger' • If more than one deta.e charge point is connected to a network, only one can be set as 'Primary Charger' • If external load management hardware has <u>not</u> been installed, e.g. smart meter, CT clamp, the Smart Meter switch must be set to Off • Total Charger Quantity – enter the quantity of EV Charge Points supplied from the consumer unit, usually set to 1 • Maximum Available Power (kW) – set to same figure as entered in Charge Current Limit, if only one charge point is connected to the properties supply • Number of Phases – select Single-phase
RCD Test	<ul style="list-style-type: none"> • The charge point simulates an earth fault – following on screen instructions
	Press Back(<) to return to the main menu showing the EV charge point serial number located in the 'Home' tab

5. The charge point should be tested using an EV charge point tester

After commissioning, the mobile device must be unlinked from the EV charge point by pressing unlink located in the 'Bluetooth connected' field

Note: If power to the charge point is lost during commissioning, Bluetooth data connection to the mobile device will be lost and the commissioning APP will disconnect from the charge point.

Once power is restored, please reconnect to the charge point by selecting the serial number from the 'Home' tab

8. Trouble Shooting – Commissioning

Item	Problems	Solutions
1	No power	<ul style="list-style-type: none">• Check the incoming supply to the charger• Check the charge point is connecting the mounting base correctly
2	No network	<ul style="list-style-type: none">• Check the RJ45 connector is fully inserted• Check the network cable continuity• Check the network settings
3	No Wi-Fi connection	<ul style="list-style-type: none">• Check the network frequency is 2.4GHz• Check the Wi-Fi signal strength• Check the network security settings• Reboot the Wi-Fi router
4	No Bluetooth connection	<ul style="list-style-type: none">• Make sure the Bluetooth is enabled on your mobile device and the charge point is powered on and operating properly• ‘Forget’ the charge point in the Bluetooth settings on your mobile device and pair the charge point to your device via Bluetooth again.• If the problem persists, contact customer support
5	Unable to register charge point	<ul style="list-style-type: none">• Check whether the QR code on the charger is consistent with the QR code on the Installation & Operation Manual. If so, make sure the Bluetooth is enabled on your mobile device; if not, contact customer support.
6	Earth fault	<ul style="list-style-type: none">• Make sure the charge point is earthed correctly.

See FAQ within the Autel® Charge APP for full list

9. Product Specification

Specification	
AC Charging Output	Maximum 7.4kW/22kW
Input Supply	230V/410V AC 50 Hz 32Amax. single or three phase
Input	1.5m flexible combined 3-phase 6mm ² power & RS485 data cable
Earthing Systems	TNC-S or TT
Connector Type	Untethered Type 2 Socket
Indications	4 LEDs multicolored
Touch Screen LCD Display	5" Touch LCD screen
Metering	Built in meter IC, $\pm 1\%$ (accuracy)
Integrated RDC-DD	AC 30mA + DC 6mA
Protection	<ul style="list-style-type: none"> • Overcurrent • PEN fault detection and isolation • Integrated surge protection
Connectivity	<ul style="list-style-type: none"> • Ethernet (RJ45) • Bluetooth • Wi-Fi (2.4GHz) • RS485 • 4G
Communication Protocols	OCPP 1.6J
Mounting	Wall-mounted or floor using an optional pedestal
Enclosure Ratings	IP54, IK08, indoor or outdoor installation
Operating Temperature	-30 to +50°C
Storage Temperature	-40 to +70°C
Safety and Compliance	<ul style="list-style-type: none"> • BS IEC/EN 61851-1 • BS EN 61851-22 • BS EN 62196-1 • BS EN 61008-1 • BS EN 60947-2 • BS IEC 62955 • The Electric Vehicles (Smart Charge Points) Regs.2021
Codes and Standards	UKCA, CE (TUV)
Load management	<ul style="list-style-type: none"> • The maximum charging current can be set within the commissioning APP • Additional hardware, e.g. MID energy meter, can be used to manage the current to the EV depending the available supply at a point in time

OPERATOR USER MANUAL

1. Overview

Description

The deta.e AC charge point is designed to charge electric vehicles (hereinafter called EVs) at your premises.

Your deta.e EV charge point is a connected product (as required by the Regulations) and requires an internet connection. The charge point needs to operate via a smart phone APP where an account needs to be registered.

The charge point default control setting is for the Autel® Charge APP. The charge point can be operated by other software as required by the CPO (Charge Point Operator).

Intended Use

The deta.e AC charge point is intended for charging of EVs only. It is suitable for both indoor and outdoor use.

This product must be installed and commissioned by an approved deta installer.

2. Safety Instructions

Safety Instructions



CAUTION

Use of the EV charge point may affect the operation of or impair any medical or implantable electronic devices, such as an implantable cardiac pacemaker or an implantable cardiovascular defibrillator. Before using the EV charge point, check with your electronic device manufacturer regarding the effects that charging an EV may have on such electronic devices.

3. Charge Point Manager Setup

Management Software

The charge point is set by default to Autel's cloud management software.

If using the Autel cloud management software, the user must download the Autel Charge APP.

If the charge point has been set to an alternative cloud management software, this should have been set up during commissioning and their APP must be downloaded by the user.

Accordingly, the user will need to be instructed which APP to download and use. Instructions within this APP will need to be followed.

When required, the unique product ID QR code can be found on the home/standby screen and on the product label on the side of the product, shown in red in the diagram.

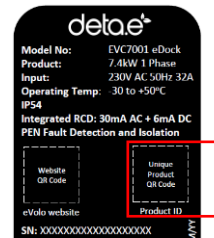

Billing

When the electrical supply is being supplied by the landlord/3rd party, the charge point account is billed for the electricity being used via the CPO. The cloud management software can be used to determine the amount electricity being used.

RFID Cards

The charge point can be controlled by the RFID cards that are supplied with it.

Additional cards can be obtained from deta-e.co.uk.

4. Using the EV Charge Point

Operation

From the home/standby screen, the Cost Details can be viewed and the language can be changed.

Button	Tap to confirm the information on the screen
Cost Details	Tap to view the charging cost
Language	Tap to choose your language for the charger
Stop	Tap to stop a charge session
Back	Tap to return to the previous screen

Start charging options

1. Use the APP
2. Use the RFID card
3. Connect the EV by inserting the charging cable – EV will start charging at the scheduled time

The charging LED on the charger should flash green.

Stop charging options

1. Use the APP
2. Use the RFID card
3. Schedule time
4. Stop button on the LCD touch screen, if enabled

Screens

Preparing to Charge Screen



Charging Screen



Transaction Details Screen

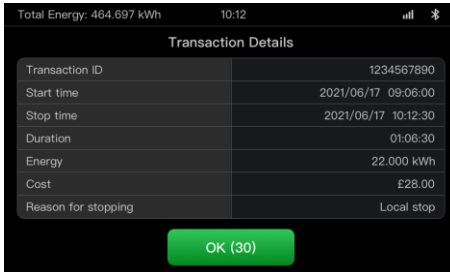

Display subject to change due to firmware updates

5. LED Indicators

LED Description	Description
Power LED	<ul style="list-style-type: none"> • Not Illuminated: The charge point is powered off • Solid Green: The charge point is powered on • Flashing Yellow: Data is being transmitted and/or firmware is upgrading • Solid Yellow: Firmware upgrade has failed • Solid Blue: Data transmission has failed; will illuminate green in five seconds
Internet Connection LED	<ul style="list-style-type: none"> • Not Illuminated: The charge point is not connected to the backend of the charging management system. • Solid Green: The charge point is connected to the internet • Flashing green: The charge point has joined the DLB (Dynamic Load Balancing) network
Charging LED	<ul style="list-style-type: none"> • Not Illuminated: The charge point is not connected • Solid Blue: An EV is connected • Flashing Blue: A schedule is active • Flashing Green: An EV is charging • Solid Green: A charge session has ended • Solid Yellow: A recoverable error has occurred or the product is temporarily disabled by the cloud server • Solid Red: An irrecoverable error has occurred (please contact technical support)
Bluetooth Connection LED	<ul style="list-style-type: none"> • Not Illuminated: The charge point is not connected via Bluetooth • Flashing Green: The charge point is connected to a mobile device via Bluetooth.

6. Trouble Shooting

	Issue	Resolution
1	The charge session does not start as scheduled	<ul style="list-style-type: none"> Do not insert the connector into your EV charging port before setting up a charging schedule for the first time. Insert the EV charging cable after the schedule is set up.
2	Power failure	<ul style="list-style-type: none"> Make sure the switch to the circuit breaker is on.
3	Over-heating	<ul style="list-style-type: none"> Check whether the EV charging cable is securely connected. Ensure the operating temperature is within the specified range on the product label. Stop charging. Restart charging until it is within the operation temperature range.
4	Residual current detected	<ul style="list-style-type: none"> Unplug the vehicle and plug in again. If the problem persists, contact customer support.
5	Bluetooth communication failure	<ul style="list-style-type: none"> Make sure the Bluetooth is enabled on your mobile device and the charge point is powered on and operating properly. 'Forget' the charge point in the Bluetooth settings on your mobile device and pair the charger to your device via Bluetooth again. If the problem persists, contact customer support.
6	Update failure via Bluetooth	<ul style="list-style-type: none"> Make sure the charge point is in idle status. Make sure the Bluetooth connection is working properly. If the problem persists, contact customer support.
7	Internet connection goes down	<ul style="list-style-type: none"> If your internet connection goes down, the charge point can be controlled by the Autel® Charge APP and pairing it using Bluetooth

7. Statement of Compliance

Statement of Compliance
Deta Electrical Company Limited declares under its sole responsibility that this charge point meets (model number on front cover) The Electric Vehicles (Smart Charge Points) Regulations 2021 The software version can be identified on the Autel® Charge APP <i>Sign for and on behalf of Deta Electrical Company Limited</i> March.2023

8. Warranty

Warranty EVC7005: eVoomXT 5-Years

deta.e charge points must be installed and commissioned by a deta approved installer, and registered at www.deta-e.co.uk, in accordance with the warranty Terms of Business, else the warranty will be void.

9. Disclaimer

All information, specifications and illustrations in this manual are based on the latest information available at the time of printing. deta.e is a brand of Deta Electrical Co. Ltd.

Deta Electrical Company Limited reserves the right to make changes at any time without notice. While information in this manual has been carefully checked for accuracy, no guarantee is given for the completeness and correctness of the contents, including but not limited to the product specifications, functions, and illustrations.

Deta Electrical Company Limited will not be liable for any direct, special, incidental, indirect damages or any economic consequential damages (including the loss of profits).

See www.deta-e.co.uk for full detail of Terms of Business



INS 0229 V2.1 01/2024 NPD 0604 A29

Deta Electrical Company Limited

UK: Panattoni Park Luton Road Chalton Bedfordshire LU4 9TT
EU: Unit 16 Ashbourne Ind. Est. Ashbourne Co. Meath A84 W972

Technical Helpline: +44(0)1582 544 548
deta-e.co.uk